

第19回ピンクリボンレディーステニス大会

愛知県予選大会

会 場： あいち健康の森公園
大会日： 6/3(金) (予) 6/17(金)

◎一般の部

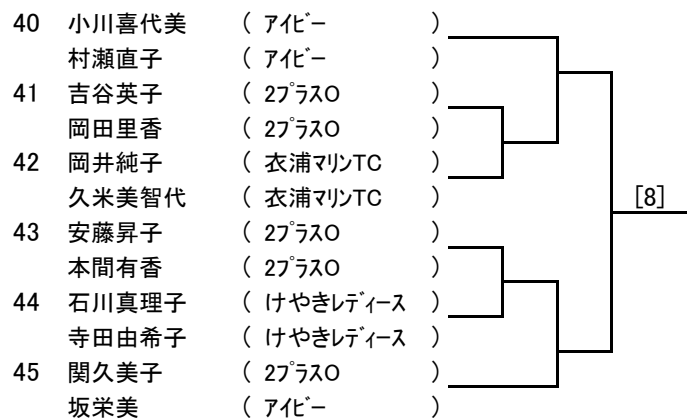
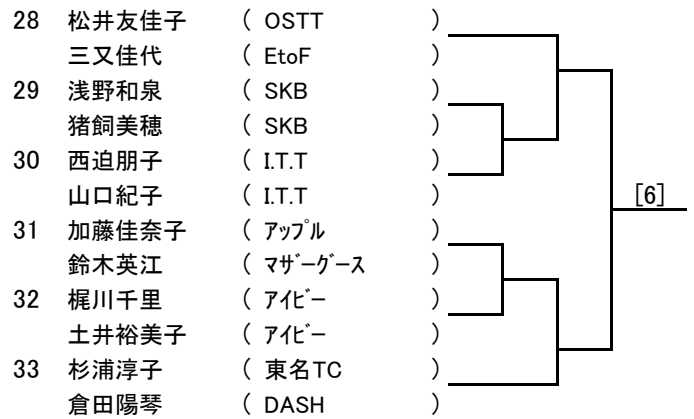
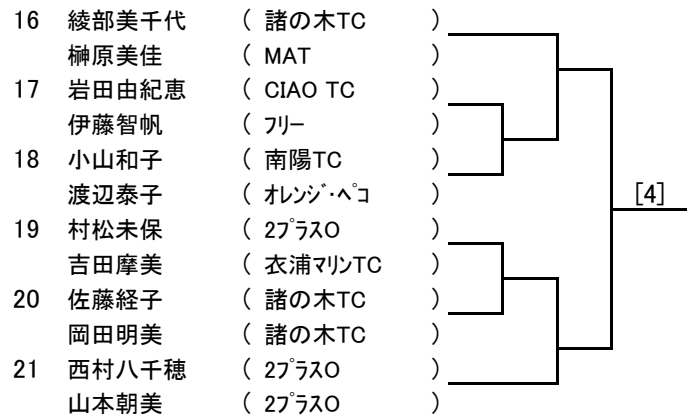
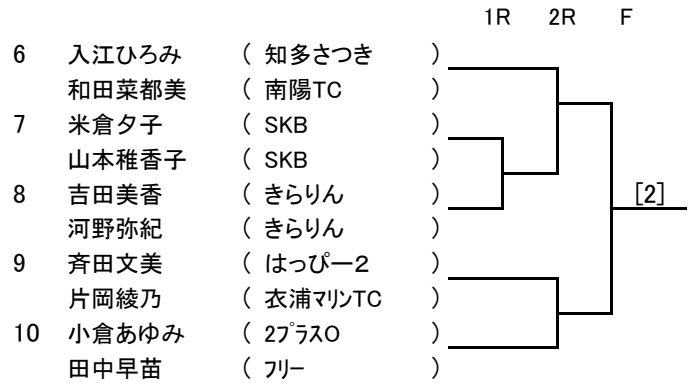
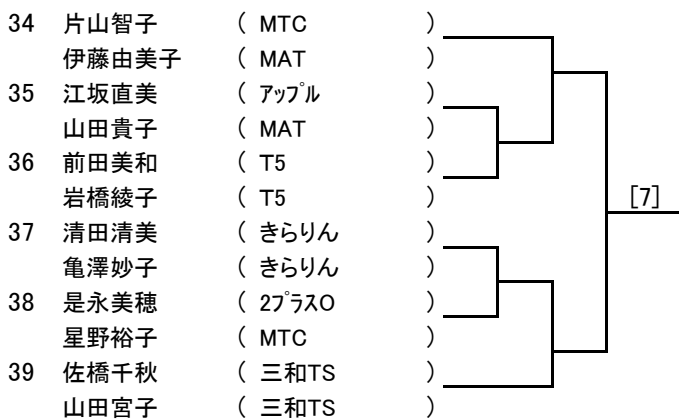
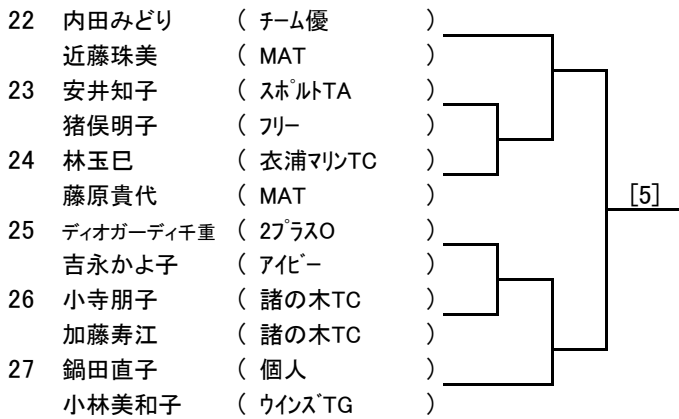
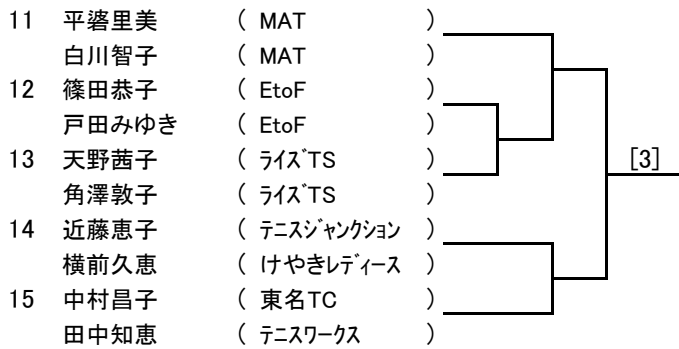
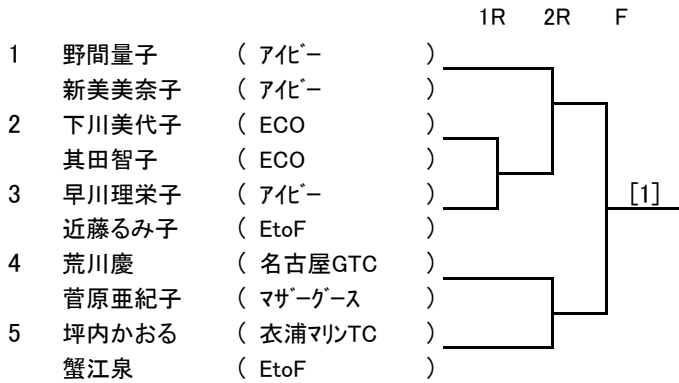

◎一般の部

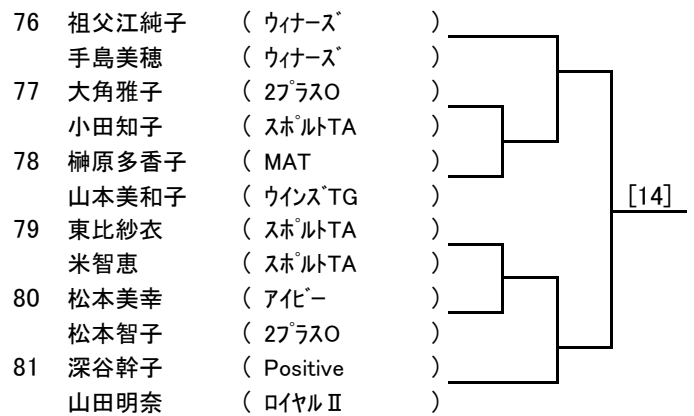
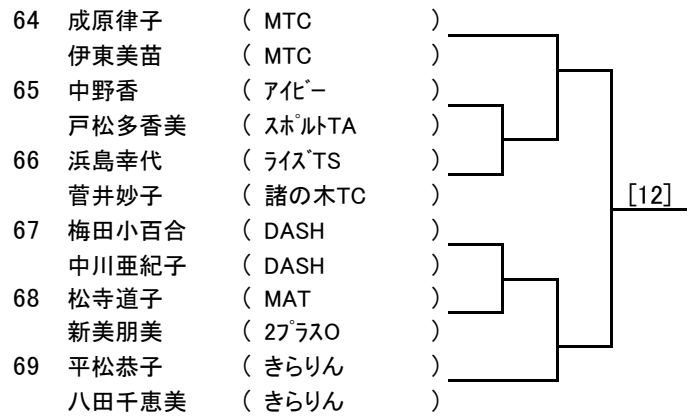
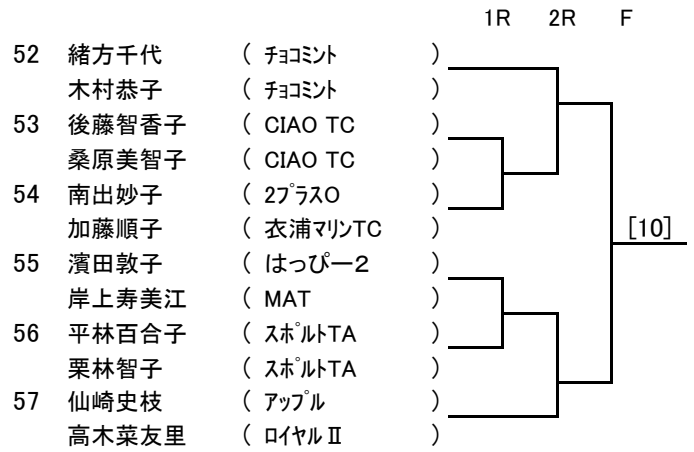
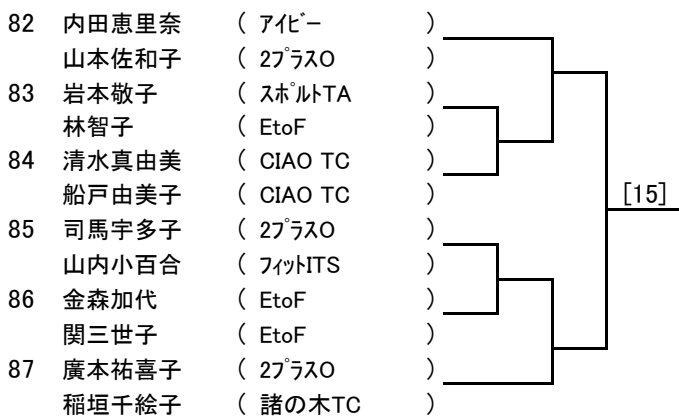
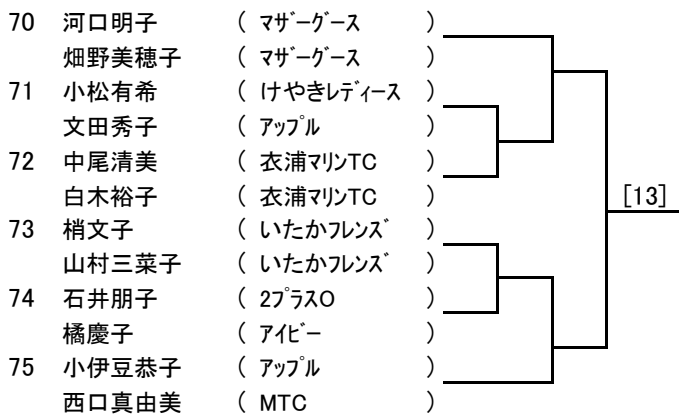
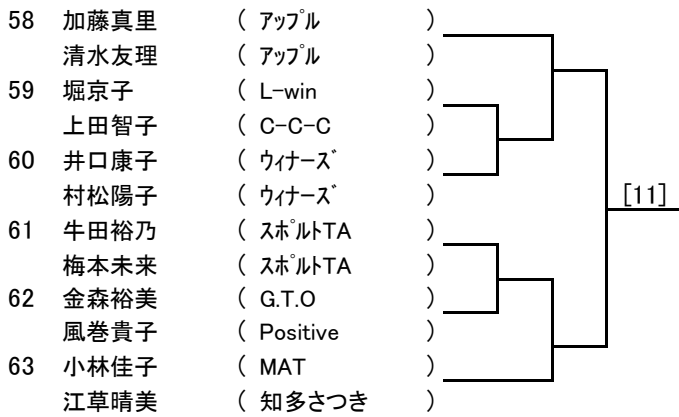
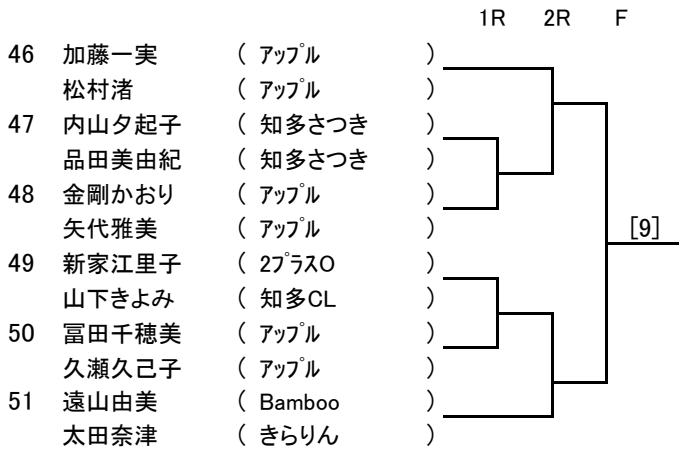

【 試合開始時間 】

1R	No.2~74	9:15
2R	No.1~33	10:30
1R	No.77~86	11:15
2R	No.34~75	
2R	No.76~87	12:00

【当日連絡先】 谷岡啓子 090-9180-9427